



# Mod. Memo AST LUX

Vemer S.p.A.

I - 32032 Feltre (BL) • Via Camp Lonc, 16  
Tel +39 0439 80638 • Fax +39 0439 80619  
e-mail: info@vemer.it - web site: www.vemer.it



## 2 DIMENSIONS

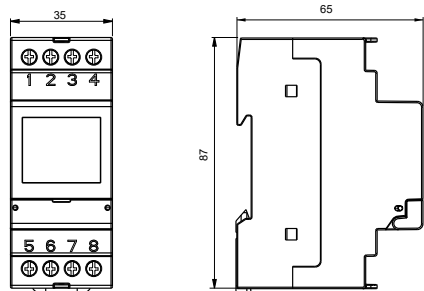

## 3 CONNECTION DIAGRAM

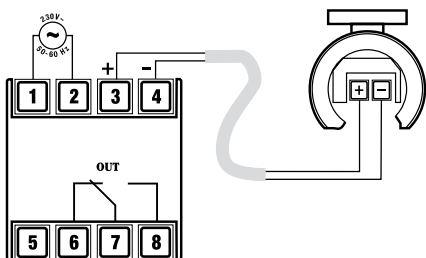

## 4 DISPLAY AND MANUAL SWITCHINGS

- General indications
- Time indication
- Relay status indication
- Channel status
- Blocked switchings
- Active random switchings
- Active holiday program
- Active manual program
- Day of the week (DAY) indication

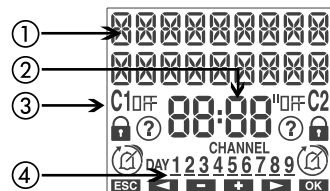

### Manual operations

- temporary on (off)**: the relay remains on (off) until the next stored program. To activate this operation, press **C1**.
- permanent on (off)**: the relay remains locked on (off) until the user unlocks. To activate this function, press for a long time (for more than 3 seconds) the key **C1**, to deactivate it, keep the key **C1** pressed again for a long time.
- random**: the relay is on and subsequently on/off switchings will be performed at random time intervals (the minimum and maximum duration of the interval can be set from the menu "Settings -> Random"). To activate this function, keep the keys **C1** and **OK** pressed at the same time and for a long time, to deactivate it press again for a long time the keys **C1** and **OK**.

## 5 TYPES OF PROGRAMS

- ON/OFF program**: it consists of a relay switching to ON and one subsequent switching of the relay to OFF. It can have daily period (all days in the same way), weekly (all weeks in the same way).
- PULSE ON (OFF) program**: it is a relay switching to ON (OFF) for a maximum duration of 59 seconds. It can have daily period (all days in the same way) or weekly (all weeks in the same way).
- HOLIDAYS program**: it is a period of time delimited by a beginning time and by an end within which all the programmed switchings (of that channel) are disabled. The relay remains in the OFF position (holiday OFF) or in ON position (ON holiday).
- NIGHT program**: program (N1, N2, ... N5) running from sunset to dawn.

**Important:** when an astro program is stored in the device, it is not possible to create time programs. Likewise if in the device is stored a time program, it is not possible to create astro programs. In the event that different programs are running at the same time, the device executes the one with the highest priority. The priority (from the highest) is the following: holidays, night, pulse, on/off.

**Important:** pulses ON and pulses OFF can not coexist (if an ON pulse is already present, it is not possible to save an OFF pulse and vice versa). Likewise, ON holidays and OFF holidays programs can not coexist.

## 1 User Manual ASTRONOMICAL TWILIGHT SWITCH WITH PROBE

Read all instructions carefully

Digital electronic switch with astronomical function and with external luminosity probe particularly indicated for the management of lighting systems, luminous signs, etc.

Code	Model	Description
VE770500	memo AST LUX	Astronomical twilight switch with probe

### SAFETY WARNINGS

- During product installation and operation it is necessary to observe the following instructions:
- The device must be installed by a qualified person, strictly in observance of the connection diagrams shown in this manual.
  - Do not power the device if any part of it is damaged.
  - The product must be installed and activated in compliance with current electric systems standards.
  - In the electrical system upstream of the device must be installed a protection device against the overcurrents.
  - Before accessing the connection terminals, make sure that the leads are not live.
  - After installation inaccessibility to the terminals without using dedicated tools must be guaranteed.
  - In case of malfunction of the device do not carry out repairs and contact technical assistance.
  - The product performs actions of type 1B and can be used in environments with Overvoltage Category III and Pollution degree 2, according to the Standard EN 60730-1.

### TECHNICAL CHARACTERISTICS

- Power supply: 230 Vac (-15% ÷ +10%) 50/60 Hz
- Power consumption: 3.5 VA (1W)
- Output: 1 monostable relay with change-over contact from 16 (10) A / 250 Vac
- Parameters of the twilight probe:
  - threshold: 3 ÷ 500 lux
  - hysteresis: 1 ÷ 50 lux
  - delay: 1 second ÷ 30 minutes
- Minimum interval for nighttime switchings off: 30 minutes
- Summer/winter time automatic update (removable)
- Active backlighting of the display with mains power
- Replaceable backup battery of CR2032 type (duration: 5 years about)
- Terminals for cables with maximum cables section of 2.5 mm<sup>2</sup>
- Storable programs: 120
- Operating temperature: -20 ÷ +50 °C
- Storage temperature: -10 ÷ +70 °C
- Operating humidity: 20÷90% non condensing
- Container: 2 DIN modules
- Protection degree: IP20
- Insulation: reinforced between accessible parts (front) and all the other terminals

## 6 INITIAL OPERATION

- Once out of the package, the device is off: press the key **OK** and wait a moment before activating the display
- The set language is Italian. To change it, press the key **OK** for at least 3 seconds. Choose among: Italian, English, Spanish, French or German and confirm with **OK**
- Make connections following the connection diagrams and power the device: the backlighting turns on permanently.
- The presence of the backup battery allows the starting with updated date and time. The other parameters are the following:

Date: - format: DD/MM/YY - 1 <sup>st</sup> day of the week: Monday	Time correction: - sunrise: +0:00 - sunset: +0:00
Astronomical coordinates: - country: Italy - city: Agrigento - latitude: North (37° 19' 12") - longitude: East (13° 34' 12") Time zone: +1:00 UTC	Parameters of the twilight probe: - threshold: 100 lux - hysteresis: 10 lux - delay: 1 second
Daylight Saving time (DST) change: active - start of daylight saving time (DST): last Sunday of March at 02:00 o'clock - end of daylight saving time (DST): last Sunday of October at 03:00 o'clock	Random switchings: - minimum: 1 minute - maximum: 5 minutes
	PIN protection: disabled (---)
	Program N1

The device can be configured as a switch "astronomical with probe" or as "programmable twilight". The configuration takes place with the creation of the first program (choosing ASTRO program or TIME program). The following diagrams show the operation in the two cases.

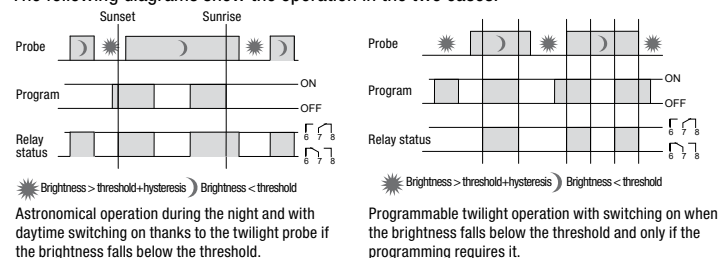

## 7 SETTINGS MENU

"Settings" menu allows you to view and eventually to modify the general operation settings of memo AST LUX, such as:

- language,
- date,
- time,
- automatic daylight saving time (DST) change,
- position (astronomical coordinates),
- interval between two random switchings,
- keys protection by PIN.

To access the "Settings" menu from the initial screen press the key **OK** and choose **SETTINGS**.

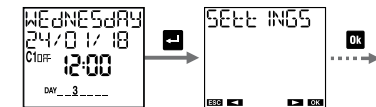

### 1 Language setting

Available languages: Italian, English, Spanish, French, German.

Quick access: from the main page it's possible to access the language setting by pressing the key **OK** for at least 3 seconds

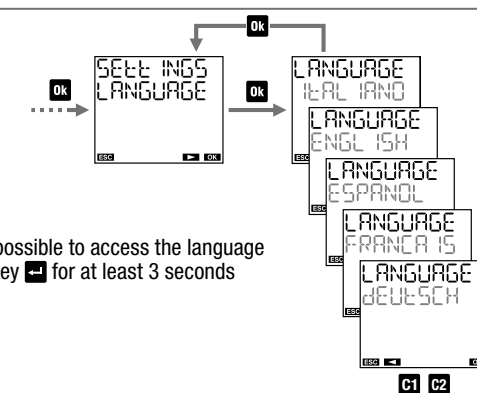

### 3 Time setting

- Set the time: hours, minutes
  - Set the time zone.
- Range:  
-14:00 ÷ +14:00  
at 15 minutes steps  
For Italy set +1:00.

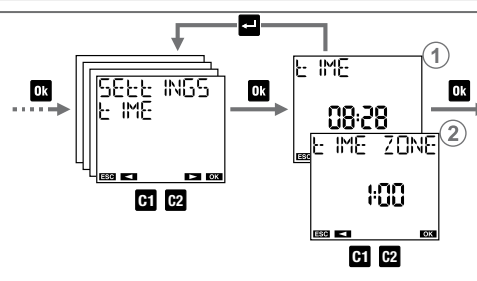

### 5 Astronomical coordinates setting

The setting of the geographical coordinates of the installation place allows to calculate sunrise and sunset times. To simplify the procedure, in the memo AST LUX, are stored the coordinates of the locations listed below; if your location is among them you can select it from the menu, otherwise it's necessary to enter the coordinates of latitude and longitude (menu 5 2).

Note: the display on point 1 shows "-----" if the astronomical coordinates have been entered instead of the province.

#### STORED LOCATION:

- all provinces for **Italy**
- the main cities of **United Kingdom, Spain, France, Germany, Finland**

The correction of sunrise and sunset times is useful for applications that require the turning on of lights in particular localities. It's possible, in fact, that the presence of disturbing elements, such as the mountains, can influence actual times of sunrise and sunset, making it necessary to advance or delay of a few minutes the calculated times.

The twilight is the time interval before sunrise, or after sunset, characterized by the permanence of the light due to the spread by the atmosphere of the Sun light. During these time intervals it's possible to distinguish clearly objects and conduct outdoor activities without using additional lighting. Therefore, in some applications it is more interesting to take as times of switching on and off the twilight (civil) in place of sunrise and sunset. With memo AST LUX it's possible to choose to turn on/off the loads depending on the times of sunrise and sunset or the civil twilight.

The correction of the calculated times also applies to the times of twilight.

To view the calculated sunrise and sunset times, from the main page press the key **OK**\*

\* The displayed times take into account any entered correction values. If the display shows "-----" means that the calculated sunrise time is later than the sunset time. If the display shows "00:00" it means that the calculated sunrise time precedes 00:00 or that the calculated sunset time is later than 23.59

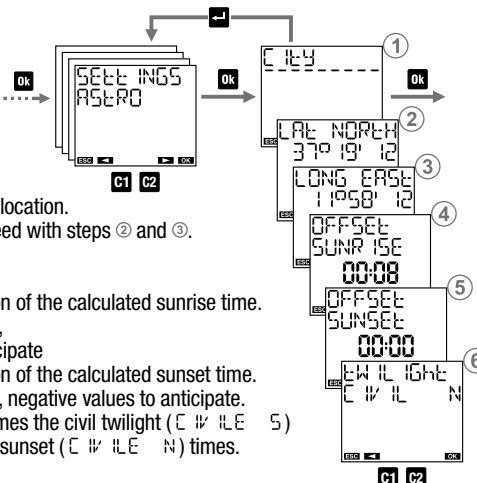

- Choose the installation location. If it's not present, proceed with steps 2 and 3.
- Set the latitude
- Set the longitude
- Set a possible correction of the calculated sunrise time. Positive values to delay, negative values to anticipate
- Set a possible correction of the calculated sunset time. Positive values to delay, negative values to anticipate.
- Choose as switching times the civil twilight (CIVIL) in place of sunrise and sunset (CIVIL) times.

### 2 Date setting

- Possible date formats: dd/MM/yy, yy/MM/dd, MM/dd/yy
- Choose, by convention, the first day of the week.
- Enter the date: day, month, year.

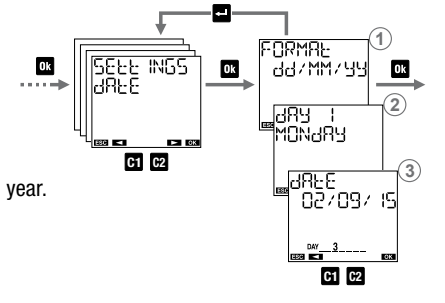

### 4 Daylight saving time (DST)/winter time (CET) change setting

- Choose to activate (AUTO ON) or to disable (AUTO OFF) the automatic time change.
- Set date and time of the winter time (CET)-daylight saving time (DST) change.
- Set date and time of the daylight saving time (DST)-winter time (CET) change

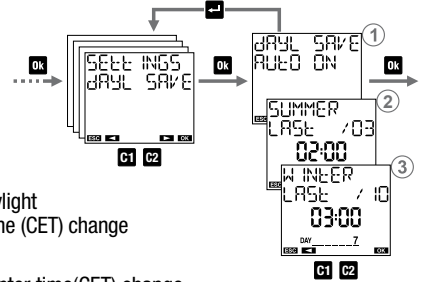

Daylight saving time (DST)/winter time(CET) change and vice versa can occur in an automatic way. In this case, memo AST LUX:

- increases by an hour in the passage from winter time (CET) to daylight saving time (DST)
- decreases by an hour in the passage from daylight saving time (DST) to winter time (CET)

For every change it's necessary to specify:

- the week of the month during which the time change occurs (first, second, third, fourth, last)
- the day of the week (Monday: 1, Tuesday: 2, ...)
- the month
- the hour and the minute

Example: in Italy the daylight saving time (DST) begins the last (LAST) Sunday (7) of March (03) at 02:00 o'clock and ends the last (LAST) Sunday (7) of October (10) at 03:00 o'clock.

### 6 Random switchings setting

The "random switching" function (activated with the combination of the keys **C1** + **OK**) allows the relay to automatically switch and at random time intervals. Default minimum duration is 1 minute, maximum duration is 5 minutes. Note: setting the minimum duration equal to the maximum duration, the switchings will occur at fixed time intervals.

- Set the minimum duration. Range: between 1 minute and the maximum duration
- Set the maximum duration. Range: between the minimum duration and 23:59 hours.

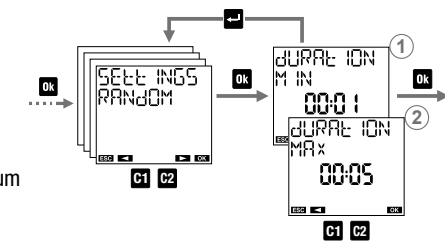

### 7 Protection PIN setting

The protection code (PIN) is used to lock the keyboard and prevent changes by unauthorized persons. With active PIN protection, pressing any key, it's necessary to enter the PIN: if PIN is correct the keyboard unlocks; after 3 minutes without pressing a key, the keyboard will lock automatically.

To activate PIN protection: set a value between 000 and 999

To disable PIN protection: set "----" (located before 000 or after 999)

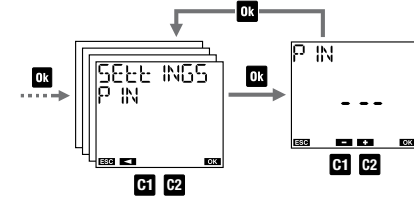

Note: If you have forgotten your PIN code, to unlock memo AST LUX it's necessary to carry out a hardware reset.

# 8 PROGRAM MENU

The menu "Program" allows you to: ① create a new program, ② check created programs, ③ change or delete a created program, ④ delete all programs

**Attention: the device leaves the factory configured as "astronomical with probe" and the set program N1.**

If you need the "programmable twilight" function, you need to delete the stored program before proceeding with the creation of the time program. Otherwise the error message ERROR 012 is shown.

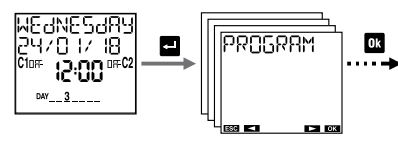

## 1 New program

### Program parameters:

- on/off: day/days (only for weekly program) and on time, day/days and off time
- on/off pulse: day/days (only for weekly program), time and pulse duration (max 59s)
- night: night/nights of the week, choice of the program, parameters of the required program

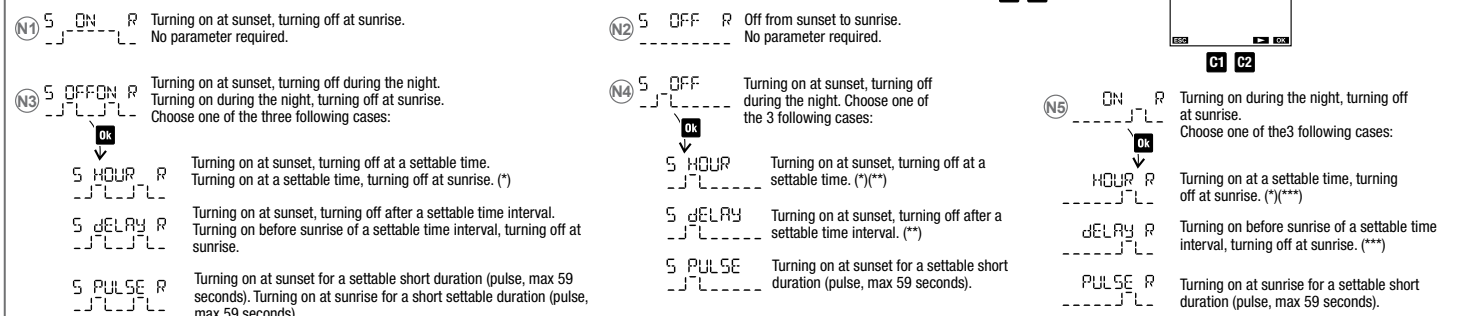

### How to choose the day (or days) in a holiday program

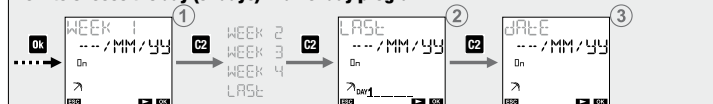

① to set the program: in the first, second, third, fourth or last week of the month in the day/s (Monday, ...) of the week just specified of the specified month (MM for all months) of the specified year (YY for all years) Note: in this case, the holiday program must begin and end in the same day. Otherwise ERROR010 is signaled

② to set the program on the last day:  
 ---/MM/YY of all months of all years;  
 ---/VV/YY of the specified VV month of all years;  
 ---/MM/ZZ of all months of the specified ZZ year;  
 ---/VV/ZZ of the specified VV month of the specified ZZ year

③ to set the program on the day XX (1,2,3...):  
 x x /MM/YY of all months of all years;  
 x x /VV/YY of the specified VV month of all years;  
 x x /MM/ZZ of all months of the specified ZZ year;  
 x x /VV/ZZ of the specified VV month of the specified ZZ year

\* If off time is before sunset, switching is not carried out.  
 If on time is after sunrise, switching is not carried out.  
 \*\* Switching continues for the entire set time interval (also if off time is after sunrise).  
 \*\*\* Switching occurs before sunrise of the entire set time interval (also if on time is before sunrise).

### How to select the nights (night programs) or the days (weekly programs):

- scrolling the nights (days) of the week from the first (1-2) to the last (7-1):
- pressing the key C2 to go to the next night (day without selecting the current night (day))
- pressing the key OK to select/deselect the current night (day) and move to the next



### How to interpret the selection in the astro night program:

If the night between the days A and B is selected, the day A is on and underlined while B is on (not underlined). Examples of selection:

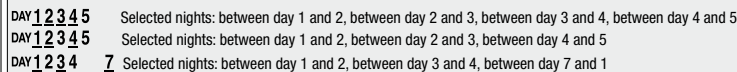

## 2 Check program

### How to check a program:

- Choose the period: daily, weekly, holiday or night
- Choose the type: on/off, on pulse, off pulse or a night program

Note: a program requires more screens to be displayed:  
 • press the key OK to move from the first to the second part of the same program  
 • press the keys C1 and C2 to switch from one program to another

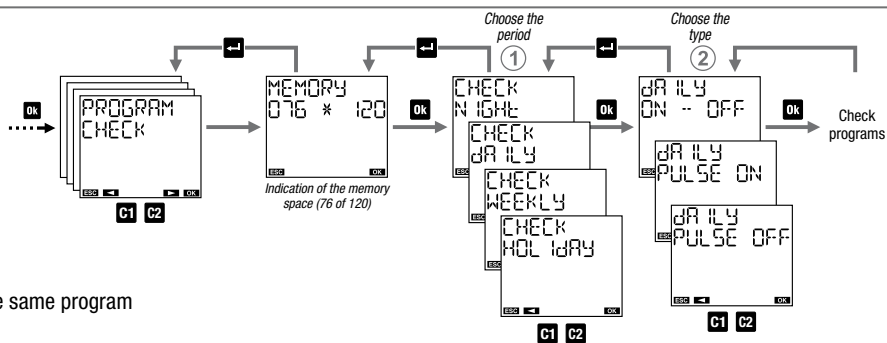

## 3 Modify programs

### How to modify or to delete a program:

- Choose the period: daily, weekly, holiday or night
- Choose the type: on/off, on pulse, off pulse or a night program

Note: a program requires more screens to be displayed:  
 • press the key OK to move from the first to the second part of the same program  
 • press the keys C1 and C2 to switch from one program to another

**To modify:** press for a long time (at least 3 seconds) the key OK  
**To delete:** press for a long time (at least 3 seconds) and simultaneously the keys OK and C1

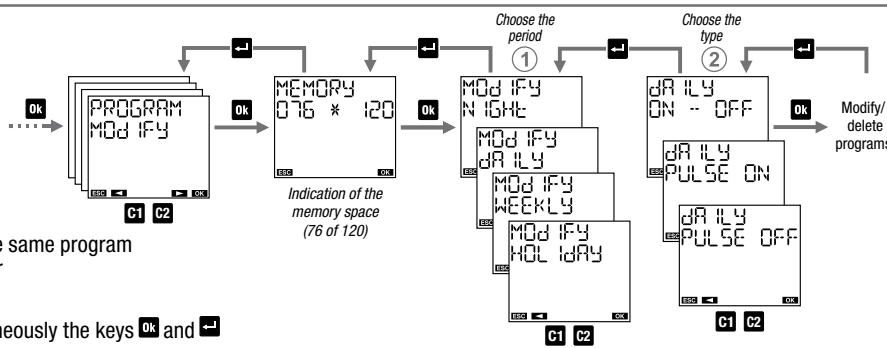

## 4 Delete program

"Delete" menu is used to delete all stored programs.

Note: to delete one single program see "modify" menu

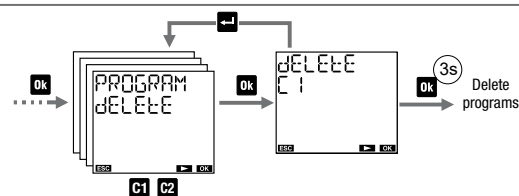

# 9 TWILIGHT MENU

The "twilight" menu allows to set the operating parameters of the external probe, that is:

**1. Intervention threshold:** set a value between 3 lux and 500 lux (increase of 1 lux up to 100 lux, of 10 lux from 100 lux up to 200 lux, of 50 lux from 200 lux up to 500 lux), or ALWAYS ON, or ALWAYS OFF.

Set ALWAYS OFF (probe consent always denied) so that the load:  
 • in the case of twilight configuration never lights up  
 • in the case of an astronomical configuration only lights up during the night (according to the set astronomical program)

Set ALWAYS ON (permanent probe consent) so that the load:  
 • in the case of twilight configuration, lights up according to set program (daily or weekly)  
 • in the case of astronomical configuration lights up during the night (according to the set astronomical program) and is always on during the day

If the setting requires always on or always off, the screen ① shows --- instead of the threshold value.

**2. Hysteresis:** set a value between 1 lux and 50 lux. For the meaning of the hysteresis value, see the operating diagrams.

**3. Switching delay:** set a value between 1 second and 30 minutes (increase of 1s for values up to 59 seconds, 1 minute for higher values).

Note: from the main screen, press for a long time (more than 3 seconds) the key OK to display the level of brightness measured by the probe at that moment. At this point, press for a long time the key OK again to set the measured value as a threshold.

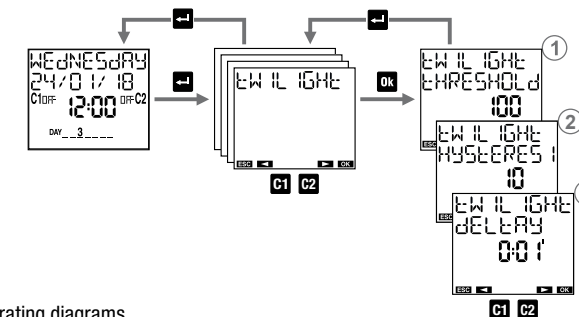

# 10 HOUR COUNTER MENU

"Hour counter" menu allows you to display the hours of use (relay on) of connected load. The maximum value of the counter is 99999 hours (about 11 years); reached the maximum limit, the counter resets automatically.

### To reset a counter:

- press the key OK for 3 seconds until the display shows "HOUR COUNTER DELETE"
- confirm by pressing OK (press C1 to exit without zeroing)

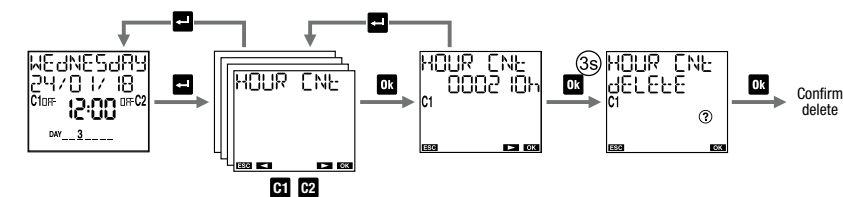

# 11 RESET MENU

"Reset" menu allows you to restore the initial state of the device.

### Available resets:

- Settings reset: deletes all the carried out settings (except the language and the PIN)
- Time programs reset: deletes all saved time programs
- Holiday programs reset: deletes all saved holiday programs
- Astro programs reset: deletes all saved astronomical programs
- Hour counter reset: resets the operating hour counter
- Reset all: carries out all the above described resets and deletes the language, PIN protection and the modes on the parameters of the twilight probe.

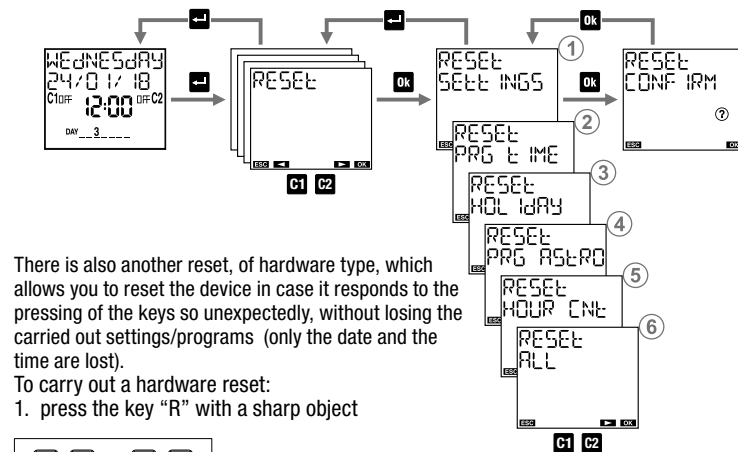

There is also another reset, of hardware type, which allows you to reset the device in case it responds to the pressing of the keys so unexpectedly, without losing the carried out settings/programs (only the date and the time are lost).

To carry out a hardware reset:  
 1. press the key "R" with a sharp object

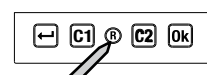

The hardware reset is also useful when you forget PIN protection. Reset, in fact, unlocks the keyboard for 3 minutes, the necessary time to access the appropriate menu and check/disable PIN.

# 12 FIRMWARE MENU

This menu shows the firmware installed in the device, where:  
 022 is the revision index  
 05 is the month  
 20 is the day

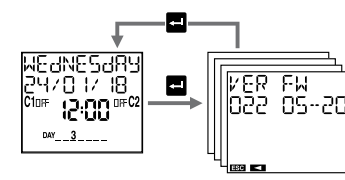

# 13 BATTERY MANAGEMENT

When the battery is close to empty, on the display appears BATTERY. In this case, the battery must be replaced as soon as possible, by removing the cover on the back.

### Use only batteries of CR2032.

**Warning:** disconnect the mains before removing the cover because this may cause the power reserve to be canceled, resulting in a loss of date and time.  
**Warning:** do not use metal objects (such as screwdrivers) to remove the battery because this may cause the power reserve to be canceled, resulting in a loss of date and time.  
**Warning:** in order not to lose date and time setting, it is necessary to ensure that the time for the battery replacement doesn't exceed 60 seconds.

Dispose of the used batteries observing the laws in force in relation to the disposal of hazardous waste.

## ERROR SIGNALS

When setting up programs, in case of a discrepancy, the following error messages can occur:

ERROR 001	on and off events with different frequency (each on event must have an off event)
ERROR 002	on and off concomitant events of the same program
ERROR 003	Two or more consecutive on events of the same program / Two or more consecutive off events of the same program
ERROR 004	Invalid date
ERROR 005	Insufficient memory
ERROR 006	Attempt to set an on pulse when is already stored an off pulse
ERROR 007	Attempt to set an off pulse when is already stored an on pulse
ERROR 008	Attempt to set an on holiday program when is already stored an off holiday program
ERROR 009	Attempt to set an off holiday program when is already stored an off holiday program
ERROR 010	Attempt to set a holiday program with on and off events on different days of the week
ERROR 011	Attempt to set an astro program when is already stored an astro program
ERROR 012	Attempt to set a time program when is already stored a program of astro type
ERROR 030	Error accessing memory*

\* In this case, carry out a hardware reset. If the error persists, contact Vemer technical support (tel.+ 39.0439.879885).

## REFERENCE STANDARDS

Compliance with Community Directives: 2014/35/EU (LVD), 2014/30/EU (EMCD) is declared in reference to the harmonized Standards: • EN 60730-2-7